

44200-03	2	15430-03	1
56415-03	2	57201-03	2
58215-03	2	57415-03	2
08530-03	1	09820-03	2
55230-03	1	09840-03	1
55430-03	1	09805-03	2
10436-03	1	09815-03	1
50685-03	1	09855-03	2
50003-03	4	09835-03	4
15230-03	1	11494-03	2
11491-03	1	09879-03	2

1

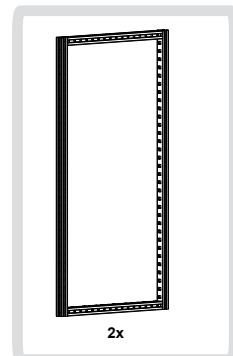

A

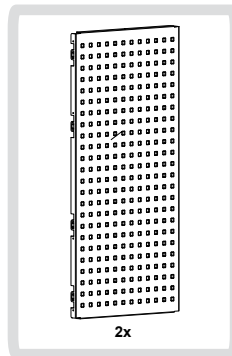
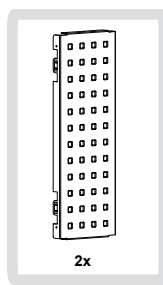
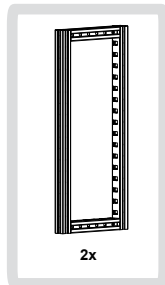
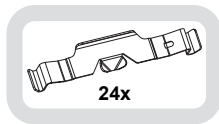
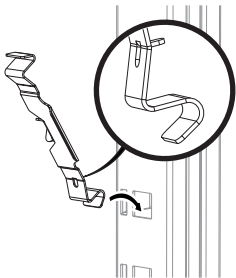

B

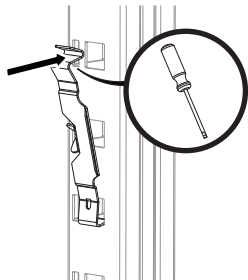

C

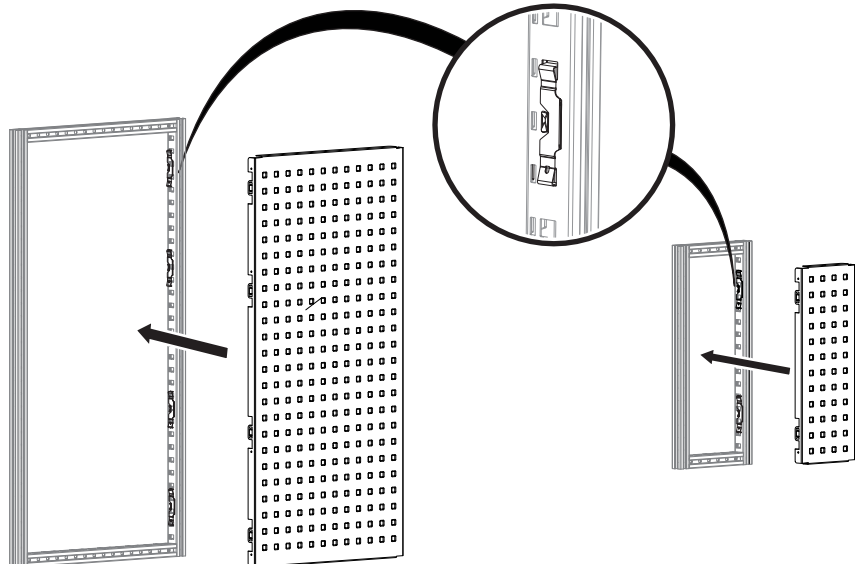



M6 x 16  
x 4

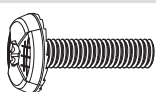

M6 x 25  
x 4

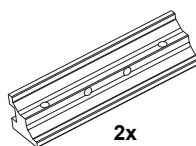

2x

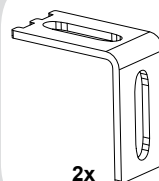

2x

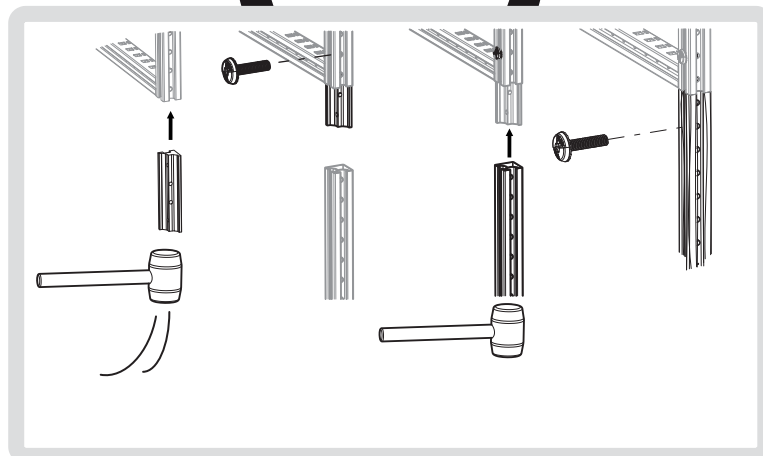
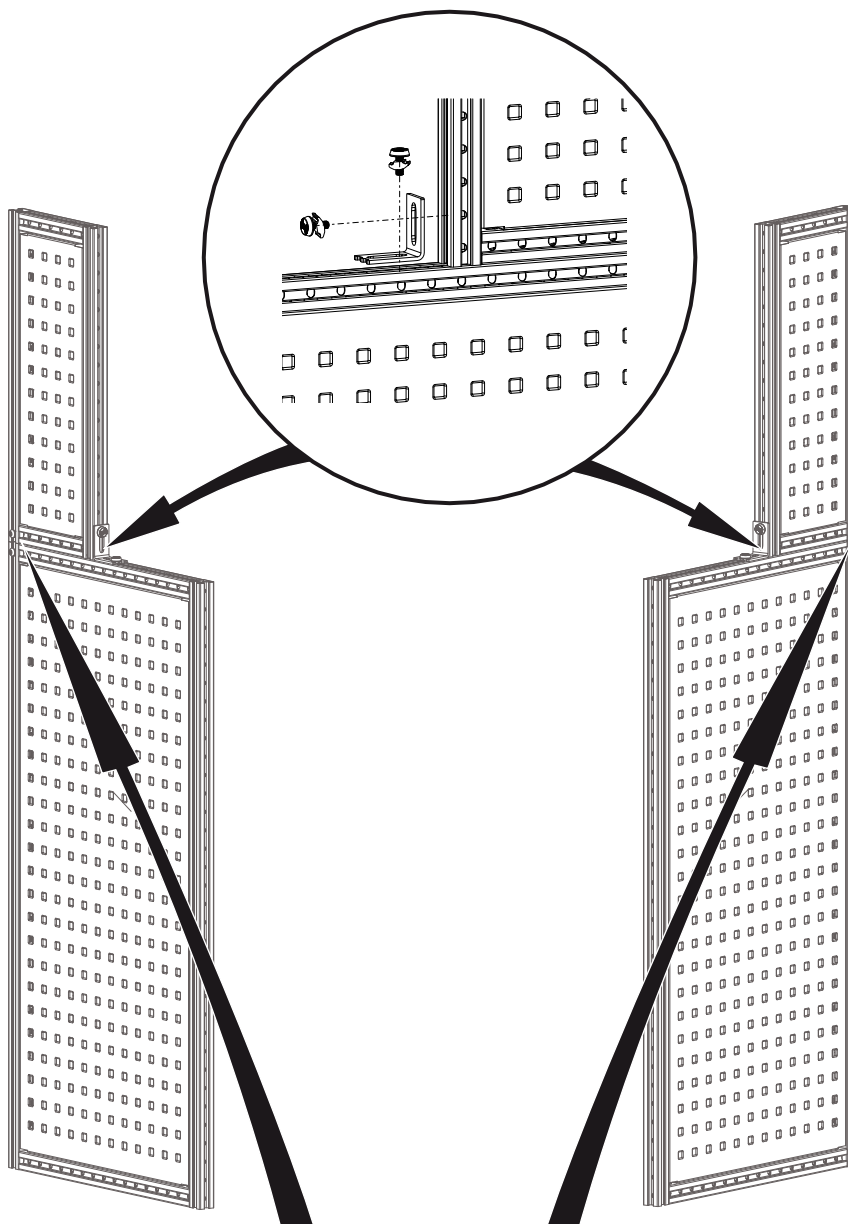

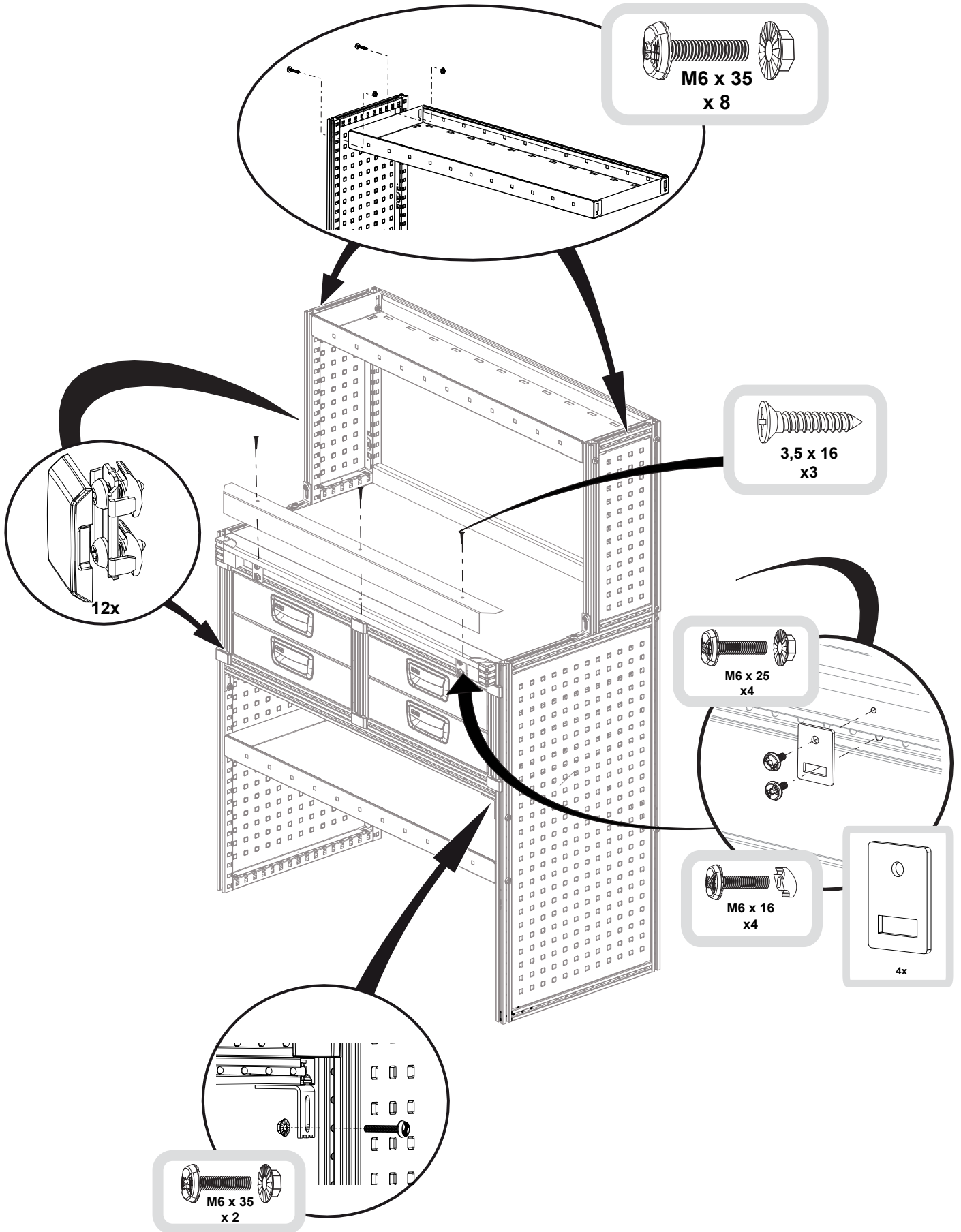

4



M6 x 16  
x 4

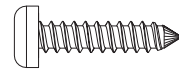
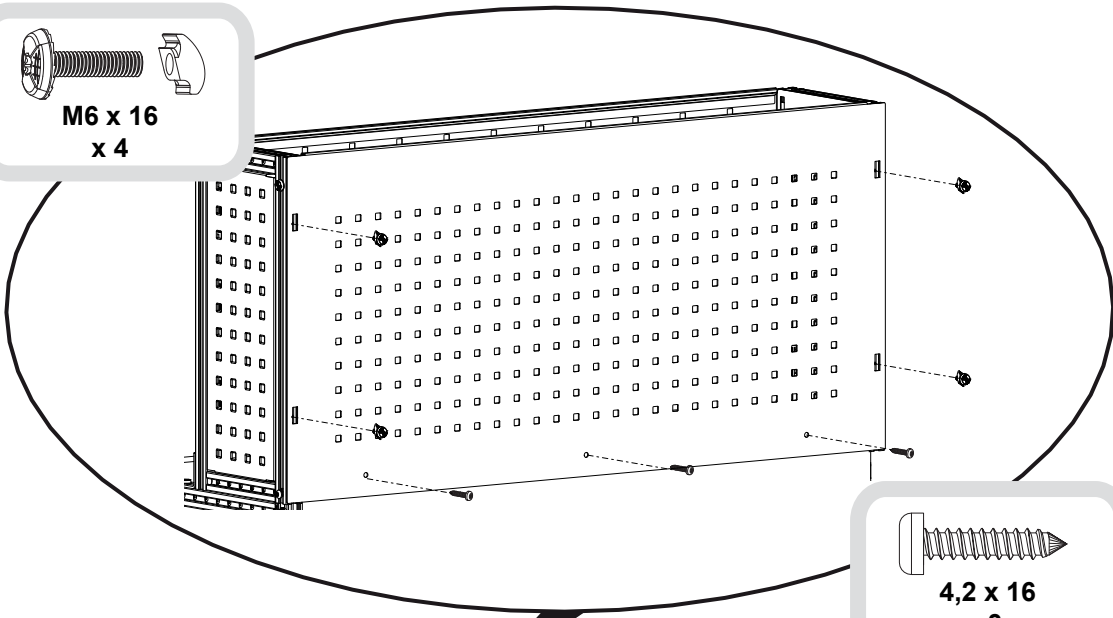

4,2 x 16  
x3

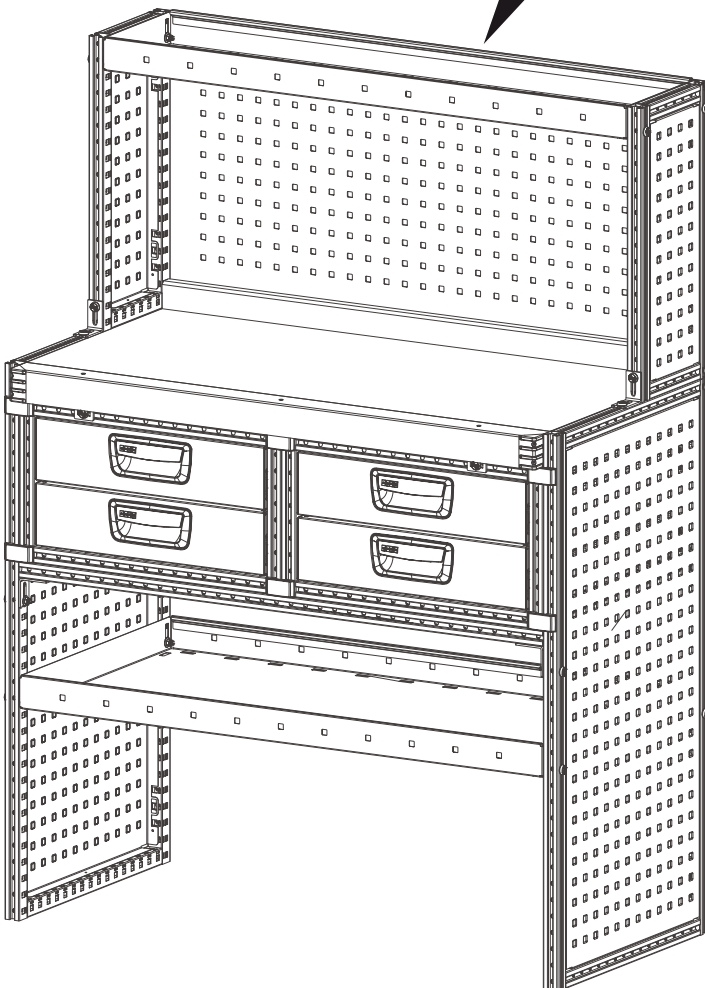

1

2

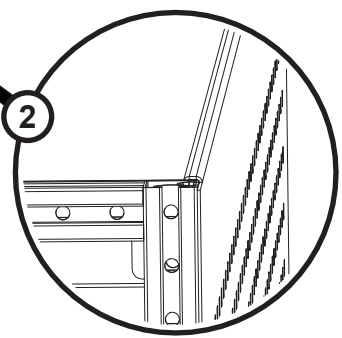
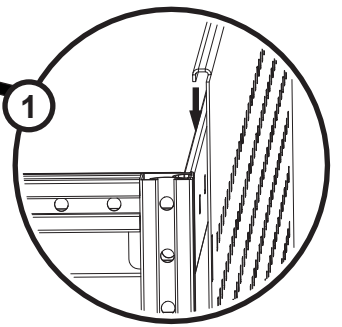

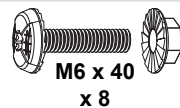
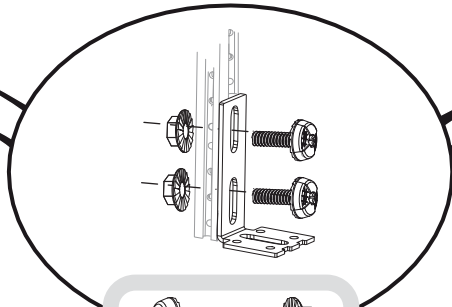
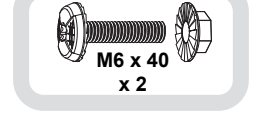
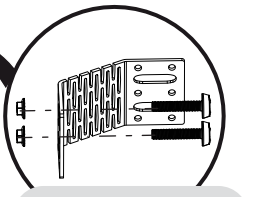
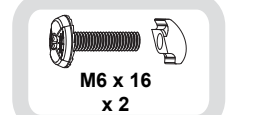
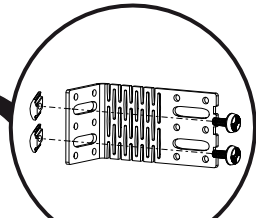
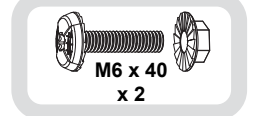
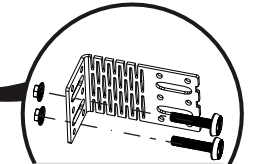
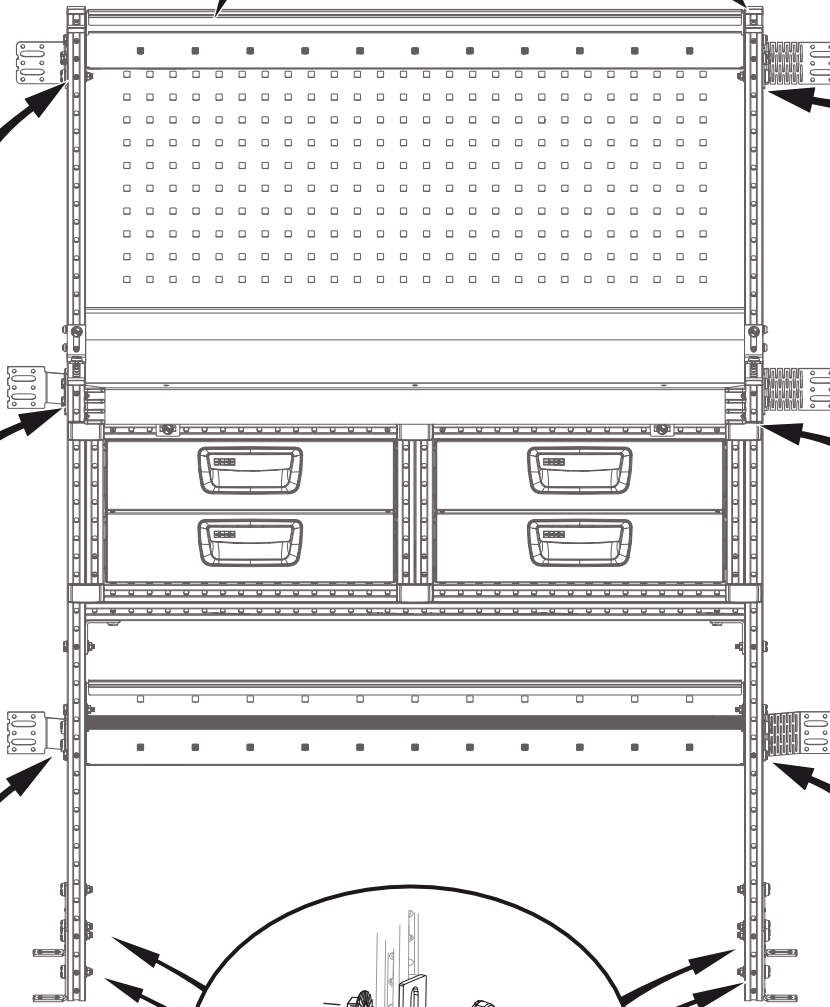
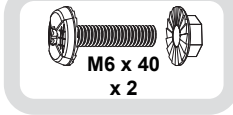
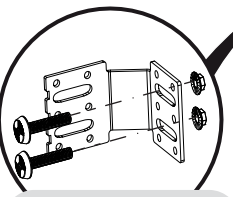
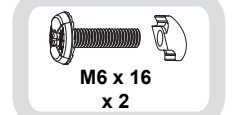
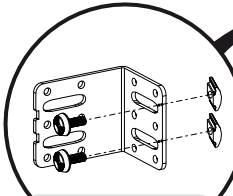
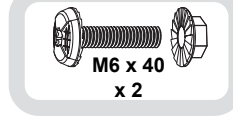
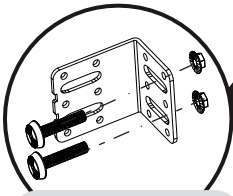
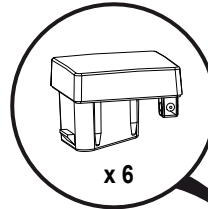
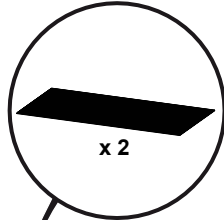
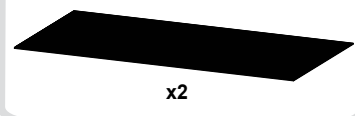
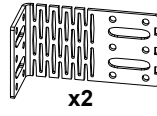
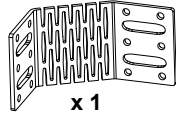
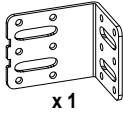
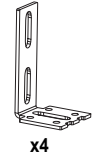
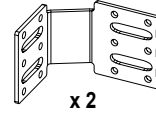
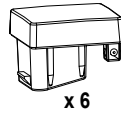
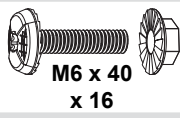
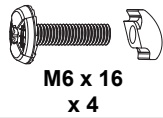

M6

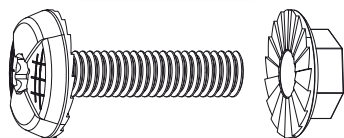

Max. 13 Nm

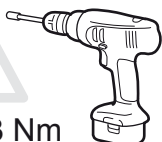

M8

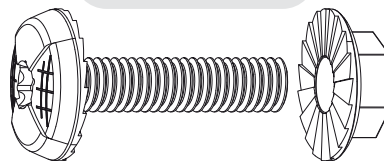

Max. 32 Nm

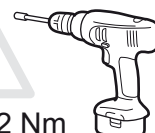

M6

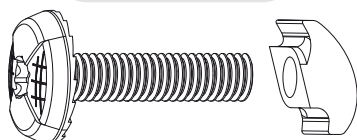

Max. 11 Nm

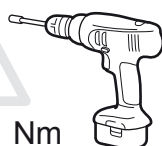

5x12



Max. 2 Nm

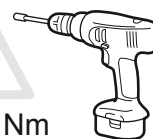

1



2

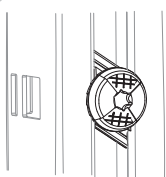

3

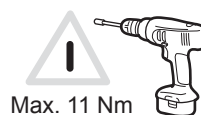
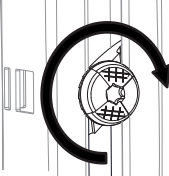

Max. 11 Nm



Ø 6,5 mm